



Video Electronics Standards Association

DDC/CI™ Standard

39899 Balentine Drive, Suite 125
Newark, CA 94560

Phone: 510 651 5122
Fax: 510 651 5127

Display Data Channel Command Interface Standard Version 1.1 October 29, 2004

Purpose

Define an I²C™ based protocol which operates over the DDC channel to provide interactive control of a display and, optional associated devices.

Summary

In response to the Plug and Play needs of end-users, VESA has defined the E-DDC standard with different levels of communication. DDC/CI (formerly known as DDC2Bi) provides bi-directional communication between the host and the display.

The communication interface is independent of display technology (CRT, LCD, PDP, etc), and is compatible with a number of different video interfaces (VGA, DVI, HDMI, etc).

PREFACE

Scope

This revision of the DDC/CI Standard is intended to extend the E-DDC standard by providing flexibility and expandability for the DDC implementations in many video interfaces. DDC/CI providing a bi-directional communication channel that can be used, along with the VESA Monitor Command and Control Set (MCCS) standard, to provide interactive control of a display.

Intellectual Property

Copyright © 1998 - 2004, Video Electronics Standards Association. All rights reserved.

While every precaution has been taken in the preparation of this standard, the Video Electronics Standards Association and its contributors assume no responsibility for errors or omissions, and make no warranties, expressed or implied, of functionality or suitability for any purpose.

Trademarks

All trademarks used within this document are the property of their respective owners. VESA, DDC, DPMS, E-DDC, EDID, E-EDID, MCCS and VDIF are trademarks of the Video Electronics Standards Association.

I²C is a trademark owned by Philips.

HDMI is a trademark of HDMI Licensing, LLC

DVI is a trademark of the Digital Display Working Group

Patents

VESA proposals and standards are adopted by the Video Electronics Standards Association without regard to whether their adoption may involve any patents on articles, materials, or processes. Such adoption does not assume any liability to any patent owner, nor does it assume any obligation whatever to parties adopting the proposals or standards documents.

Support for this Standard

Clarifications and application notes to support this standard may be written. To obtain the latest standard and any support documentation, contact VESA.

If you have a product which incorporates DDC/CI, you should ask the company that manufactured your product for assistance. If you are a manufacturer, VESA can assist you with any clarification you may require. All comments or reported errors should be submitted in writing to VESA using one of the following methods.

- Fax 510 651 5127, *direct this note to Technical Support at VESA*
- e-mail support@vesa.org (with subject: DDC/CI)
- mail to Technical Support
 VESA - Video Electronics Standards Association
 39899 Balentine Drive, Suite 125
 Newark, CA 94560

Revision History

Version 1 August 14, 1998

Initial release of the standard

Version 1.1 October 29, 2004

Major reorganization and expansion of sections that detail command structures

Added support for “table class” of VCP commands

Appendix on color adjustment deleted

Appendix added on possible problems if DDC/CI and HDCP (High Definition Content Protection) are both being used.

Support for EDID within the capability string eliminated

Power management priority given to DPM (over DPMS)

Acknowledgments

This document would not have been possible without the efforts of the VESA Display Systems Standards (former Display) and Japan Committees. In particular, the following individuals and their companies contributed significant time and knowledge.

Ian Miller	Samsung	DDC/CI Task Group Chair
Syed Athar Hussain	ATI Technologies Inc.	
Bryan Speece	Entech Taiwan	
Eiichi Mori	Fujitsu	
Eiji Kurimoto	Fujitsu	
Shinji Tsutsumi	Fujitsu	
Yuichiro Wada	Fujitsu	
Graham Loveridge	Genesis Microchip	
Moriyoshi Ohara	IBM Japan	
Shiro Makino	EIZO NANA O	
Tadahiko Hiraka	EIZO NANA O	
Takuma Ishida	EIZO NANA O	
Hiroaki Sugiura	Mitsubishi	
Yoshifumi Sato	NEC Plasma Display	
Jack Hosek	NEC-Mitsubishi (US)	
William Hollingworth	NEC-Mitsubishi (US)	
Hideki Tanizoe	NEC-Mitsubishi	
Kazuaki Takamoto	NEC-Mitsubishi	
Kazuyuki Iimura	NEC-Mitsubishi	
Takashi Katagiri	NEC-Mitsubishi	
Kouichi Ara	NEC-Viewtechnology	
Takashi Nirasawa	NEC-Viewtechnology	
Yoshihisa Kudou	NEC-Viewtechnology	
Isaac Yang	NVIDIA	
Masafumi Ikeda	Pioneer Corp	
Michael Anderson	Portrait Displays Inc.	
Keijiro Naito	Seiko Epson	
Shinji Kubota	Seiko Epson	
Chikaho Abe	Sony	
Satoru Suzuki	Sony	
Shigeru Takasu	Sony	
Steve Hasegawa	Sony	
Joe Lamm	Tech Source	
Katsuki Hazama	THine Electronics	
Mitsugu Yui	Totoku Electric Co. Ltd.	
Alain d'Hautecourt	ViewSonic	

Terms and Abbreviations

Abbreviation	Description
CRT	Cathode Ray Tube (display technology type)
E-DDC	[VESA] Enhanced Display Data Channel (serial communication)
DDC2B	Simplest of the DDC2B modes defined in VESA E-DDC standard
DDC2Bi	Former name for DDC/CI
DPM	[VESA] Display Power Management standard
DPMS	[VESA] Display Power Management Signaling standard
E-EDID	[VESA] Enhanced Extended Display Identification Data
EEPROM	Electrically Erasable Programmable Read Only Memory (memory type)
HW	Hardware
I ² C	Trademark of Philips
LCD	Liquid Crystal Display
MCCS	[VESA] Monitor Control Command Set
MCU	Micro Controller Unit (Embedded in application)
MT	I ² C Bus Master Transmitter Communication Mode
MR	I ² C Bus Master Receiver Communication Mode
SR	I ² C Slave Receiver Communication Mode
ST	I ² C Slave Transmitter Communication Mode
SW	Software
VCP	Virtual Control Panel
VDIF	[VESA] Video Display Identification Format
VESA	Video Electronics Standards Association

TABLE OF CONTENTS

1. OVERVIEW	9
1.1 SUMMARY.....	9
1.2 BACKGROUND.....	9
1.3 VCP CODES.....	9
1.4 STANDARD OBJECTIVES.....	10
1.5 REFERENCE DOCUMENTS.....	11
1.6 I ² C BUS NOTATION.....	12
2. DDC/CI SYSTEM ARCHITECTURE	13
2.1 DDC/CI INTRODUCTION.....	13
2.2 DDC/CI HOST DEVICE.....	13
2.3 DDC/CI DISPLAY DEVICE.....	13
2.4 DISPLAY DEPENDENT DEVICES.....	14
2.5 FIXED I ² C SLAVE ADDRESS DEVICES.....	14
3. DDC/CI HARDWARE IMPLEMENTATION	15
3.1 HOST DEVICE.....	15
3.2 DISPLAY DEVICE.....	15
3.3 DISPLAY DEPENDENT DEVICES.....	15
3.3.1 External Display Dependent Devices.....	15
3.3.2 Internal Display Dependent Devices.....	15
3.4 FIXED ADDRESS I ² C DEVICES.....	16
4. DDC/CI COMMUNICATION BASIC COMMANDS	17
4.1 DDC/CI COMPLIANCE REQUIREMENTS.....	17
4.1.1 VCP Capabilities.....	17
4.1.2 MCCS Version.....	18
4.2 OPTIONAL SUPPORT.....	18
4.2.1 E-EDID Information.....	18
4.3 GET VCP FEATURE & VCP FEATURE REPLY.....	19
4.4 SET VCP FEATURE.....	20
4.5 SAVE CURRENT SETTINGS.....	20
4.6 CAPABILITIES REQUEST & CAPABILITIES REPLY.....	21
4.7 GET TIMING REPORT & TIMING MESSAGE.....	22
4.8 "TABLE" COMMANDS.....	23
4.8.1 Table Write.....	23
4.8.2 Table Read.....	24
5. COMMUNICATIONS PROTOCOL	25
6. DDC/CI SOFTWARE IMPLEMENTATION	26
6.1 DATA RETURN FORMAT : DISPLAY TO HOST.....	26
6.2 GRAPHIC HOST TO DISPLAY DEVICE MESSAGES.....	26
6.3 DISPLAY DEVICE TO GRAPHIC HOST MESSAGES.....	27
6.4 DEFINITION AND USE OF THE "NULL MESSAGE".....	28
6.5 COMMUNICATION BETWEEN THE HOST AND ITS DEVICES.....	29
6.5.1 Message Buffer Size Requirements.....	29

6.6	I ² C BUS TIMINGS	29
6.7	MESSAGES SUPPORT	30
6.7.1	Power Management.....	30
6.7.2	ID String.....	30
6.7.3	Capability String.....	30
6.7.4	Vendor Specific Messages.....	30
6.7.5	Application Specific Messages.....	31
6.7.6	Hot Plugging Mechanism.....	31
7.	DDC/CI SUPPORT OF DISPLAY DEPENDENT DEVICES	32
7.1	EXTERNAL DISPLAY DEPENDENT DEVICE	32
7.1.1	Message Sent to the External Device.....	32
7.1.2	Message Sent (Reply) from the External Device.....	32
7.2	INTERNAL DISPLAY DEPENDENT DEVICE.....	32
7.2.1	Message Sent to the Internal Device.....	32
7.2.2	Message Sent (Reply) from the Internal Device.....	32
7.3	DETECTION OF DISPLAY DEPENDENT DEVICE	32
7.4	EXAMPLE OF INTERNAL AND EXTERNAL DEVICE COMMUNICATION.....	33
7.5	DEPENDENCIES BETWEEN THE DISPLAY AND INTEGRATED DEVICES.....	34
8.	DDC/CI IMPLEMENTATION EXAMPLES.....	35
8.1	MULTIPLE VIDEO INTERFACE SUPPORT AND IMPLEMENTATION	35
8.2	TELEVISION/HOME THEATER SUPPORT AND SPECIFIC COMMANDS	35
8.3	VIDEO SWITCH BOXES	35
8.4	MULTIPLE DISPLAY SUPPORT	35
8.5	VIDEO PROJECTION DISPLAYS	36
9.	DDC/CI COMPLIANCE.....	37
9.1	EXISTING DISPLAY DESIGNS	37
9.2	NEW DISPLAY DESIGNS	37
9.3	EXISTING GRAPHIC HOST SYSTEMS.....	37
9.4	NEW GRAPHIC HOST SYSTEMS	37
10.	APPENDIX A: CO-EXISTANCE OF DDC/CI AND HDCP	38
11.	APPENDIX B: DPM (DPMS) AND MCCS POWER MANAGEMENT	39
12.	APPENDIX C: SUMMARY OF OP. CODES	40
13.	APPENDIX D: ANSWERS TO COMMONLY ASKED QUESTIONS.....	41

Table 1 : DDC Modes	9
Table 2 - Reference Documents.....	11
Table 3 - I ² C Notation.....	12
Table 4 : Examples of External Display Dependent Devices	15
Table 5 : Examples of Fixed I ² C Address devices.....	16
Table 6 : I ² C Bus Notation.....	17
Table 7 : Capability String Fields	30
Table 8 - FAQ.....	41
Figure 1: Key Elements of a DDC/CI System.....	13
Figure 2 - Recommended SCL and SDA Line Terminations	37

1. OVERVIEW

1.1 Summary

This standard defines a bidirectional communications channel between a host device and a display using the Display Data Channel (defined in the VESA E-DDC standard) as the physical layer. Implementation allows interaction between the host and display devices.

The main changes in this revision are the provision of support for the ‘table class’ of VCP codes introduced in the MCCS standard version 2 and to restructure and expand the explanations of command structures. Minor changes included elimination of the references to unused standards and other points to improve clarity.

1.2 Background

Table 1 summarizes the various DDC modes (old and current), the purpose of each and current status. Some modes and terms are no longer recommended. The fields with a gray background show older standards or terminology that is not recommended. ... note that all new designs are recommended to support E-DDC addressing and those requiring support for the MCCS VCP codes are recommended to also support DDC/CI.

Name	Purpose	Comment
DDC1	Original uni-directional mode (display → host)	Not recommended for new designs
DDC2	Original bi-directional mode. Host able to request EDID data	Not recommended for new designs
DDC2B	A generic term for all bi-directional DDC modes	Not recommended terminology
DDC2Bi	Original name for command interface mode	Old terminology, replaced by DDC/CI
E-DDC	Enhanced DDC, a bi-directional mode, supporting access to EDID data including all possible EDID extension blocks	Recommended for <u>all</u> new display designs Note: This is base level of support recommended for all new display designs. Some designs will choose to implement DDC/CI to provide additional functions.
DDC/CI	The command interface uses I ² C single master communications and allows MCCS VCP codes and associated data to be sent to or received from a display	Recommended for new display designs when support for the MCCS VCP codes is required. Note: This does not replace the need for E-DDC support, DDC/CI complements E-DDC.

Table 1 : DDC Modes

1.3 VCP Codes

Commands used over the DDC/CI channel are known as VCP Codes (Virtual Control Panel) – see the VESA MCCS standard for details. (Complete reference to MCCS in “Table 2 - Reference Documents”.)

Version 2 of MCCS provides a much more complete set of VCP codes with particular emphasis on the needs of new (e.g. LCD, PDP) technologies.

1.4 Standard Objectives

DDC/CI was developed by VESA to meet, exceed and/or complement certain criteria. These criteria are set forth as Standard Objectives as follows :

- Provide display controls using the DDC2B HW standard, making DDC/CI displays compatible with existing and pervasive DDC2B compliant hosts.
- Support Microsoft® Plug and Play definition.
- Compatible with existing E-DDC levels.
- Ensure scaleable, low cost, fast market acceptance and implementation.
- Provide information in a compact and scaleable format to allow the graphic subsystem to be configured based on the capabilities of the attached display.
- Provide for communication between the graphic host and other display dependent devices.
- Provide for integration of display dependent devices in the display device.
- Display technology independence.

1.5 Reference Documents

Note: Versions identified here are current, but users of this standard are advised to ensure they have the latest versions of referenced standards and documents.

Source	Name	Version / Date
VESA	Video BIOS extensions for Display Data Channel (VBE/DDC)	1.1 / Nov. 1999
	Enhanced Extended Display identification Data (E-EDID)	A.1 / Feb. 2000
	Monitor Command and Control Set (MCCS)	2 / Oct. 2003
	Enhanced Display Data Channel (E-DDC)	1 / Sep. 1999
	Display Power Management Standard (DPM)	A / March 2003
	Display Power Management Signalling Standard (DPMS)	1 / August 1993
	Video Image Area Definition Standard (VIAD)	1.0 / August 1993
	Access Bus Specification (not a VESA specification)	3.0 / September 1995
Philips	The I ² C Bus Specification	2.1 / Jan. 2001
Microsoft	Windows and the Plug and Play Framework Architecture	March 1994
	Plug and Play for Windows 2000 and Windows XP	December 2001
	Windows XP – Plug and Play Overview	
	Plug and Play Technology	December 2001
Digital Content Protection, LLC	High-bandwidth Digital Content Protection (HDCP)	1.1 / June 2003

Table 2 - Reference Documents

1.6 I²C Bus Notation:

Note that this notation is case sensitive.

S	Start bit	Generated by the master to start communication (Bus becomes BUSY)
XX	Data byte, hexadecimal	Made of 8 data bits, may be sent or received by the master
a	Acknowledge bit	This bit is sent in the opposite direction than the data bits
n	Non acknowledge bit	Signals the end of the data transfer, a stop bit should follow to free the bus
P	Stop bit	Signals the end of the communication, the bus becomes free.
CHK	Checksum	Checksum (Exclusive OR)
CHK'	Checksum	Checksum computed using the 0x50h virtual host address
VCP	VCP code	Used when one of several VCP codes may be used.

Table 3 - I²C Notation

See the Philips I²C Specification for a full description of these terms – complete reference in section 1.5.

2. DDC/CI System Architecture

2.1 DDC/CI Introduction

This protocol is based on the DDC2B HW definition in the VESA E-DDC standard. The message protocols are defined in this standard.

DDC/CI compliant designs shall comply with the requirements of the Philips I²C Specification (see section 1.5, Reference Documents). Of particular importance are the logic levels on the interface to ensure interoperability.

Figure 1 shows the key elements of DDC/CI implementation, the host device (often a PC) acts as an I²C Single Master Host and the display acts as an I²C Slave Device.

For DDC/CI communications, only two signals are involved, the serial clock (SCL) generated by the host and the bidirectional data (SDA) lines.

The maximum transfer rate in “standard-mode” is 100 kb/s equivalent to a maximum clock rate of 100 kHz. Note that this standard will assume “standard-mode” operation in all examples but this does not preclude operation in either “fast-mode” (400 kb/s) or “high-speed mode” (3.4Mb/s) – see I²C specification for details.

No 10-bit I²C bus slave devices can be present on the DDC/I²C Bus.

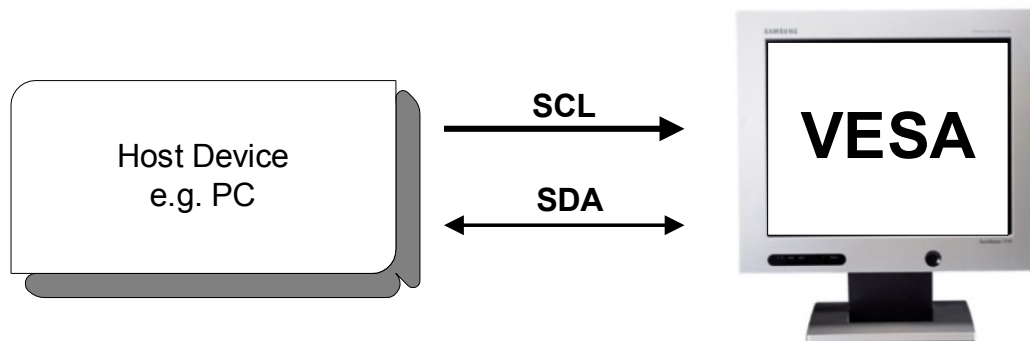

SCL - Serial Clock

SDA - Serial Data

Figure 1: Key Elements of a DDC/CI System

2.2 DDC/CI Host Device

The DDC/CI host is considered as an I²C single master capable device with a “virtual” I²C slave address of 0x50h / 51h.

2.3 DDC/CI Display Device

The DDC/CI display is considered a fixed address display device at address 0x6Eh / 6Fh, and uses only I²C slave mode to communicate with the host.

2.4 Display Dependent Devices

A display dependent device is physically located around or within the display and follows the same DDC/CI data protocol as the display device. Pointers, calibration and audio devices are examples of possible display dependent devices.

2.5 Fixed I²C Slave Address Devices

This category of devices groups all the existing stand-alone and “dumb” I²C slave devices, such as memories, TV tuners, audio processors, etc.

These devices can coexist and be connected to the DDC I²C bus. However, it is strongly recommended to limit their number, and locate them in the host.

These devices are not expected to support hot-plugging nor to follow the DDC/CI data protocol, and as such, must be considered custom devices.

3. DDC/CI Hardware Implementation

3.1 Host Device

HW requirements are similar to a DDC2B capable host.

3.2 Display Device

The hardware requirements are similar to a DDC2B capable display.

3.3 Display Dependent devices

Display dependent devices are classified into two types, external and internal, which can coexist without conflict.

External devices are physically outside the display cabinet and may be detachable, internal devices are physically inside the display cabinet and will not usually be detachable.

3.3.1 External Display Dependent Devices

Some of these devices may be connected to the DDC I²C Bus: To avoid conflict with the Display Slave address, a fixed I²C address is defined for each device. Table 4 shows some examples. The address range is 0xF0h to 0xFFh: up to 8 additional external display dependent devices can be added on the DDC bus. As such, the 10 bit I²C addressing mode is not supported..

I ² C Slave Address	Display Dependent Device Type	Example
0xF0h / F1h	Pointer	Touch Screen, Light pen or Remote Control Track Ball
0xF2h / F3h	Audio Device	Speaker / Microphone
0xF4h / F5h	Serial Communication	Home Network IF (power line modem)
0xF6h / F7h	Calibration Device	Luminance Probe or Colorimeter
0xF8h / F9h	Input Device	IR keyboard and remote control pad (shared IR channel)
0xFAh / FBh	Reserved	Reserved for future use
0xFC h / FDh	Reserved	Reserved for future use
0xFEh / FFh	Reserved	Reserved for future use

Table 4 : Examples of External Display Dependent Devices

3.3.2 Internal Display Dependent Devices

A display dependent device may be integrated inside the display device structure, and as such becomes part of the display device, not directly connected to the DDC I²C bus. The device dependent function is accessed through the display device. (See section 7 for more details.)

3.4 Fixed address I²C devices

Table 5 shows examples of devices that can be connected to the same I²C / DDC bus, each must have a 7 bit I²C slave address.

The I²C addresses are defined and registered by Philips.

I ² C Slave Address	I ² C Device
0x12h / 13h	Smart Battery Charger
0x14h / 15h	Smart Battery Selector
0x16h / 17h	Smart Battery
0x80h / 81h	Audio Processor
0x40h / 41h	PAL / NTSC Decoder
0xA0h / A1h	DDC2B Monitor (memory)

Table 5 : Examples of Fixed I²C Address devices

4. DDC/CI COMMUNICATION BASIC COMMANDS

A DDC/CI display shall support the following commands and functions, support for other commands and structures is optional.

Note that VCP codes are fully defined in the MCCS standard – see section 1.5 for complete reference.

S	Start bit	Generated by the master to start communication (Bus becomes BUSY)
XX	Data byte, hexadecimal	Made of 8 data bits, may be sent or received by the master
a	Acknowledge bit	This bit is sent in the opposite direction than the data bits
n	Non acknowledge bit	Signals the end of the data transfer, a stop bit should follow to free the bus
P	Stop bit	Signals the end of the communication, the bus becomes free.
CHK	Checksum	Checksum (Exclusive OR)
CHK'	Checksum	Checksum computed using the 0x50h virtual host address
VCP	VCP code	Used when one of several VCP codes may be used.

Table 6 : I²C Bus Notation

Note that commands limit the data length to fragments of 32 bytes, this is to minimize the potential for bus contention and to keep the required buffer size in the display to a reasonable size/cost.

4.1 DDC/CI Compliance Requirements

4.1.1 VCP Capabilities

Monitor shall support the "vcp()" strings.

The supported enumeration value of the non-continuous VCP codes which have multiple values shall be described as follows:

Example:

VCP(10 12 14(01 02 04 05 08))

Above string means that Contrast, Brightness and Select Color Presets (sRGB, Native, 5000°K, 6500°K and 9300°K) are supported.

VCP 10h : Brightness

VCP 12h : Contrast

VCP 14h : Select Color Preset

Color temperature presets available using VCP 14h

01h : sRGB

02h : Display native

04h : 5000°K

05h : 6500°K

08h : 9300°K

4.1.2 MCCS Version

The supported MCCS version can be determined by the following:

A display compliant with this standard can support either MCCS version 1 or version 2 - version 1 is limited and primarily provides support for CRT displays.

```
mccs_ver()
```

Example:

```
mccs_ver(2)
```

```
2h      MCCS version 2 is supported
```

4.2 Optional Support

4.2.1 E-EDID Information

E-EDID information may be retrieved as follows:

Definition: `e_edid_sel(block header Revision number (offset1(data1 data2)offset2()))`

Example:

```
e_edid_sel(40 01(02(00)0C(01 02 00)18(00)))
```

Above string allows the selected portions of a DI-EXT block (RGB sub-pixel and vertical pixel stripe orientation).

40h	The EDID extension tag for a DI-EXT block
01h	DI-EXT block revision number
02h	Offset 1 of 02h into DI-EXT block – “digital interface”
00h	Data associated with offset 1. 00h indicates that the display supports an analog interface
0Ch	Offset 2 of 0Ch into DI-EXT block – “digital interface”
01h	Data associated with offset 2. 01h indicates a RGB sub-pixel layout
02h	Data associated with offset 2. 02h indicates a stripe configuration
00h	Data associated with offset 2. 00h indicates that sub-pixel shape is undefined
18h	Offset 3 of 18h into DI-EXT block is added to previous offsets 1 and 2 to give a combined offset of 26h – “aspect ratio conversion modes”
00h	Data associated with offset 3. 00h indicates that display does not support aspect ratio conversion

4.3 Get VCP Feature & VCP Feature Reply

Sequence:

- Send a request from host to the display for the adjustment data corresponding to a specified VCP code.
- Wait
- Receive the current setting data from the display to the host for the adjustment specified by the VCP code.

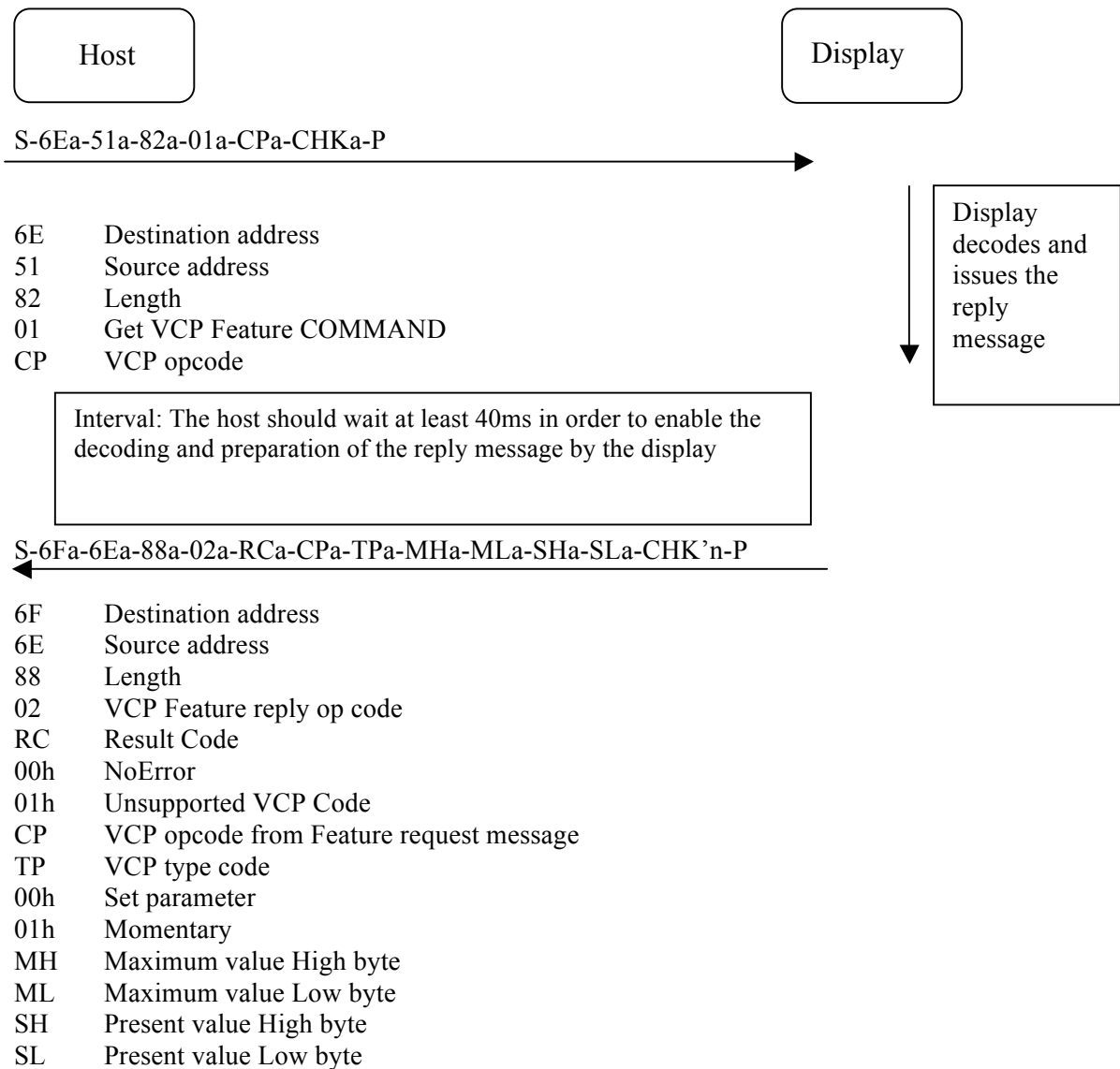

4.4 Set VCP Feature

Send the adjustment data from host to the display corresponding to a specified VCP.

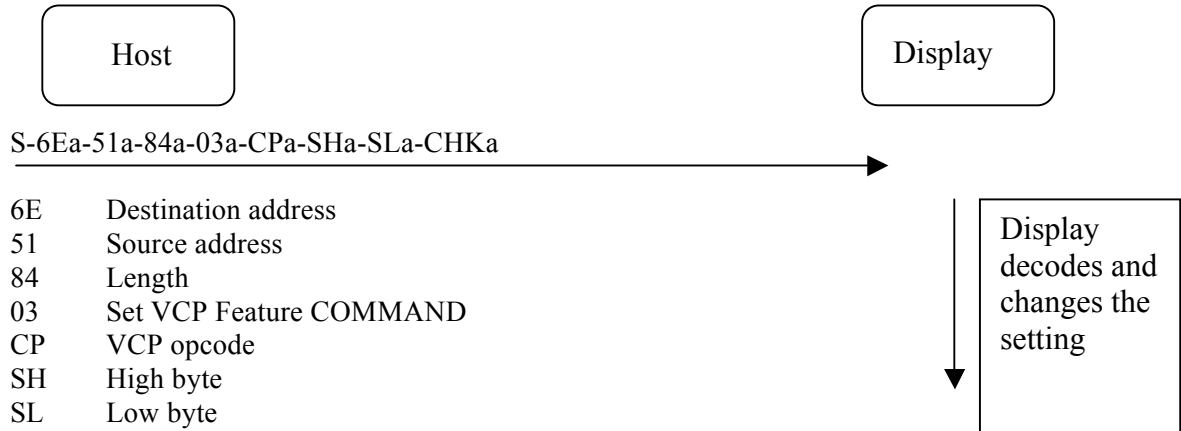

Interval : The host should wait at least 50ms to ensure next message is received by the display.

4.5 Save Current Settings

Save the current adjustment data to EEPROM (or other non-volatile storage) inside the display.

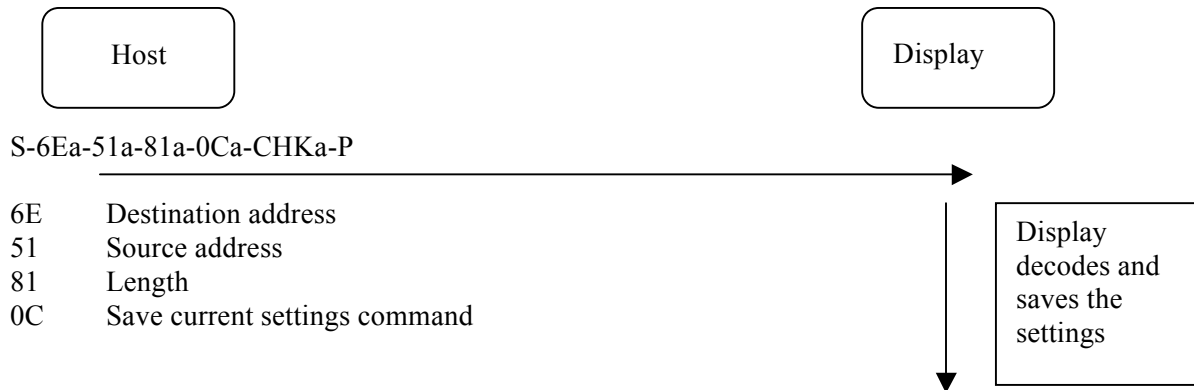

Interval : The host should wait at least 200ms before sending the next message to the display.

4.6 Capabilities Request & Capabilities Reply

Send a request from host to the display for the display capabilities string data.

After waiting a certain period, receive the capabilities string data from the display to the host.

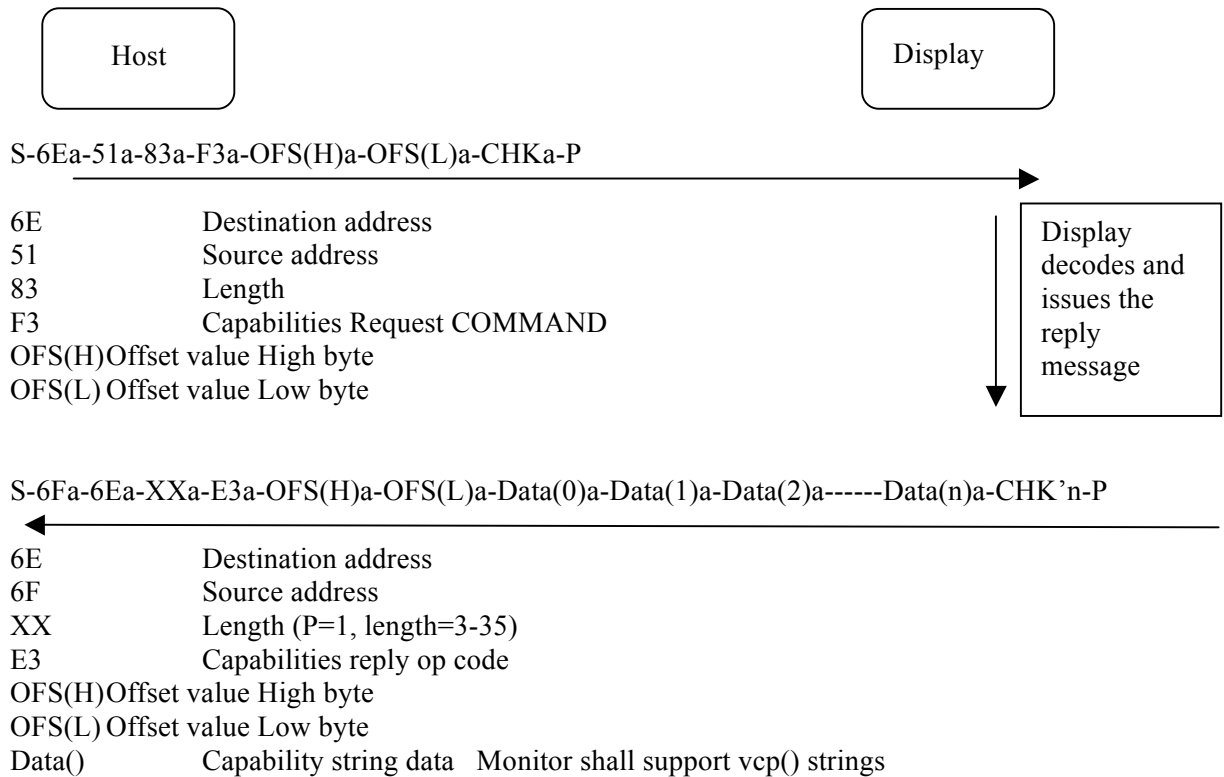

Example:

(vcp(10 12 16 18 1A 50 92))

The maximum data length in a fragment is 32 bytes.

Interval : The host should wait at least 50ms before sending the next message to the display.

The protocol is designed to be simple for the display to implement: The display is free to choose the most convenient fragment size from one message to the next.

The only state information the device needs to maintain is the current offset and length of the most recently transmitted fragment.

On receiving a Capabilities Request message, the display shall examine the "offset" field:

- If equal to zero, the display shall set the current offset to zero and send the fragment from offset zero (0).
- If equal to the current offset, the display shall re-send the fragment from the current offset.
- If equal to the "current offset" + "fragment length", the display shall update the current offset (current offset := current offset + fragment length) and then look up (or calculate) the next fragment to send and send it.
- If the display has reached end-of-string, it shall send a fragment with the next offset but zero data bytes. This will indicate an end of string.
- Otherwise, the display shall set the "current offset" to zero and send the fragment from offset 0.

4.7 Get Timing Report & Timing Message

Send a request from the host to the display for the currently operating video signal timing report data.
 After waiting certain period,
 Receive the timing report data from the display to the host.

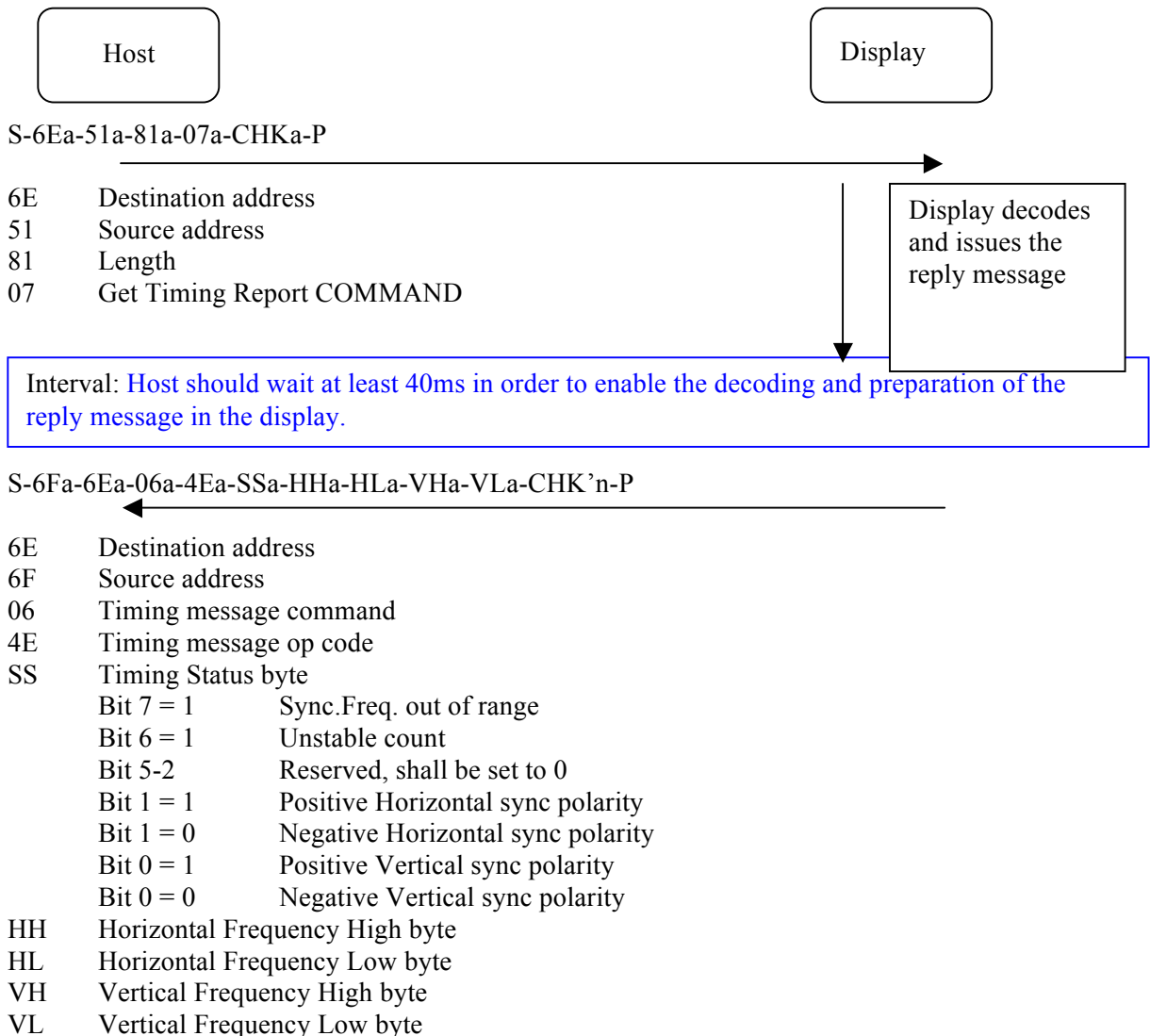

Interval : The host should wait at least 50ms before sending the next message to the display.

4.8 “Table” Commands

This section supports the “Table” type of VCP introduced in the VESA M CCS version 2 standard. At the time of writing, this includes VCP codes 73h, 74h, 75h, 76h, C3h and CFh – please check latest revision of M CCS standard for updates.

4.8.1 Table Write

Write a block of data from the host to the display.

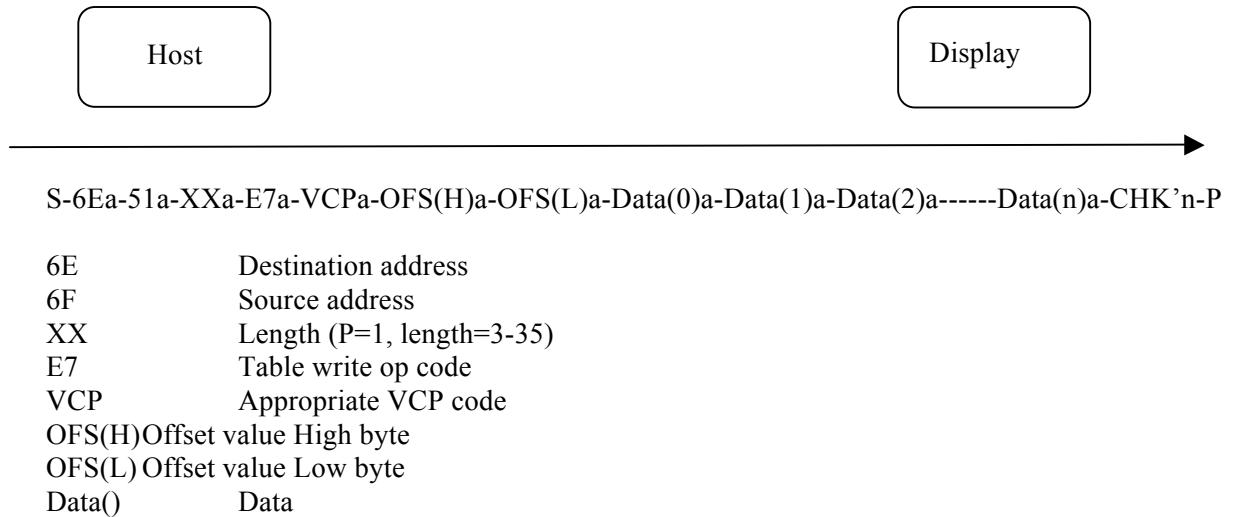

Interval : The host should wait at least 50ms before sending the next message to the display.

The maximum length that can be transferred is 32 bytes to minimise bus contention. Some transfers will require several operations to transfer data in 32 byte fragments.

4.8.2 Table Read

Send a request from the host to the display for a block of data to be transferred. After waiting a certain period, receive data block from the display to the host.

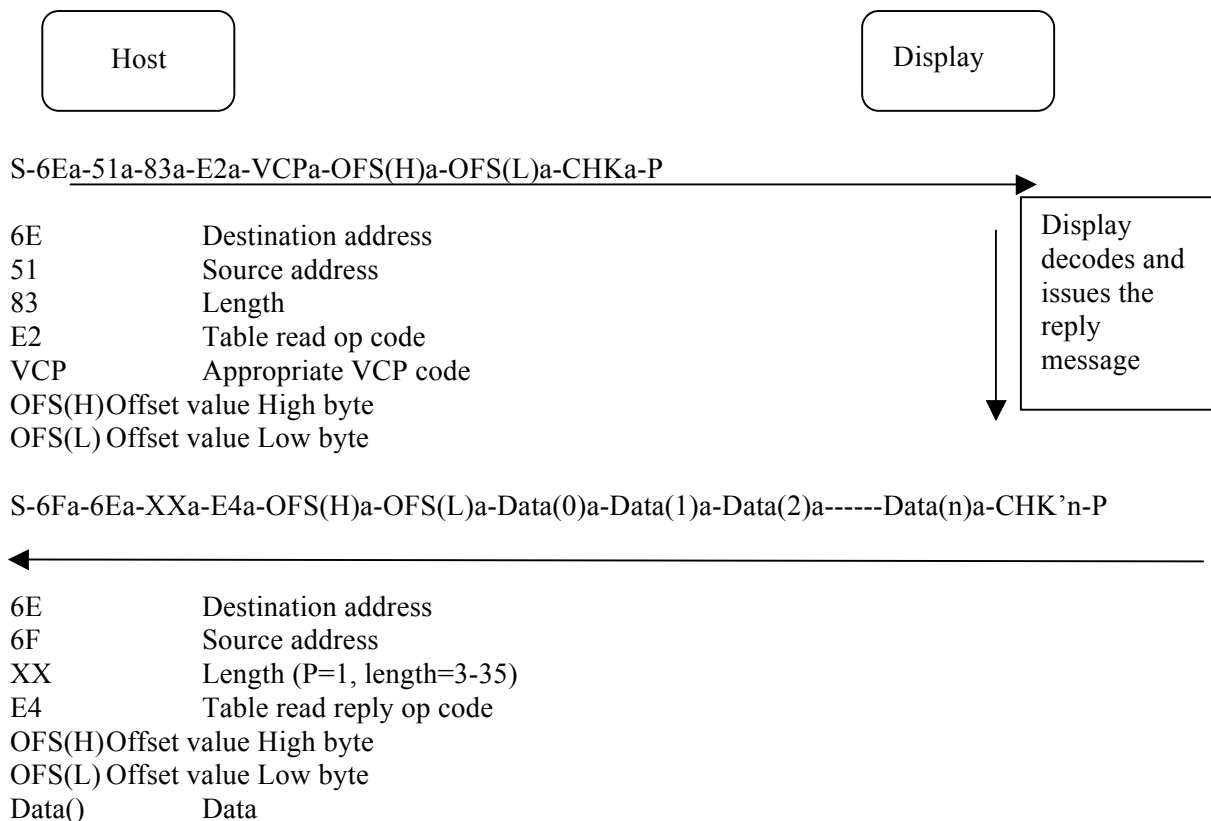

The maximum data length in a fragment is 32 bytes.

Interval : The host should wait at least 50ms before sending the next message to the display.

The protocol is designed to be simple for the display to implement: The display is free to choose the most convenient fragment size from one message to the next.

The only state information the device needs to maintain is the current offset and length of the most recently transmitted fragment.

On receiving a Table Read message, the display shall examine the "offset" field:

- If equal to zero, the display shall set the current offset to zero and send the fragment from offset zero (0).
- If equal to the current offset, the display shall re-send the fragment from the current offset.
- If equal to the "current offset" + "fragment length", the display shall update the current offset (current offset := current offset + fragment length) and then look up (or calculate) the next fragment to send and send it.
- If the display has reached end-of-string, it shall send a fragment with the next offset but zero data bytes. This will indicate an end of string.
- Otherwise, the display shall set the "current offset" to zero and send the fragment from offset 0.

5. Communications Protocol

With DDC/CI, there is no concept of retry when a communication fails (bus error, bad checksum):

It is the responsibility of the host to re-send its message and try to get an answer from the display again. Host should wait the "Interval" time defined for each command type. Display shall reply with a "null" message if it cannot reply in time or if the command is not supported.

Null message;

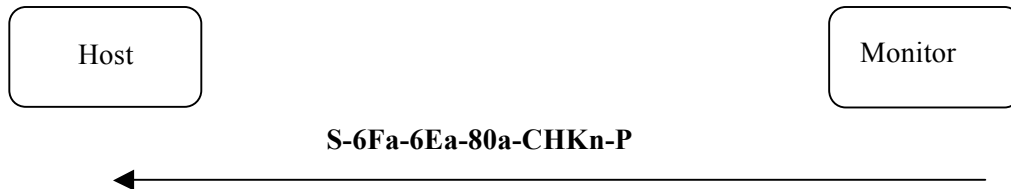

If no communication is established then the host shall retry a minimum of three times with 40ms wait period before retrying and between each retry.

6F	Source address
6E	Destination address
80	Length
CHK	Checksum
n	'Non acknowledge bit' signalling end of data transfer.

6. DDC/CI Software Implementation

DDC/CI communication structures are defined in this section.

6.1 Data Return Format : Display to Host

S-6Fa-6Ea-XXa-E3a-OFS(H)a-OFS(L)a-Data(0)a-Data(1)a-Data(2)a-----Data(n)a-CHK'n-P

6E	Destination address
6F	Source address
XX	Length (P=1, length=3-35)
E3	Capabilities reply op code
OFS(H)	Offset value High byte
OFS(L)	Offset value Low byte
Data()	Capability string data Monitor shall support vcp() strings

Example:

(vcp(10 12 16 18 1A 50 92))

The maximum data length in a fragment is 32 bytes.

6.2 Graphic Host to Display Device Messages

In order to tell the display that the received message is of DDC/CI type, the Source Address Byte bit 0 is set to 1.

Example: The graphic host wants to enable the Display Application Messages

The graphic host sends an "Enable Application Report" message:

Host to Display: MT to SR

DDC/CI Sequence: S-6Ea-51a-82a-F5a-01a-49a-P

6E	Destination address
51	Source address
82	Length
F5	Enable display application op code
01	Data
49	Checksum

6.3 Display Device to Graphic Host Messages

When the graphic host expects an answer from the display, the host READS the answer message at the display device Slave Address 0x6F. Note that the checksum is still computed by using the 0x50 virtual host address.

Example: The graphic host wants to get the Display Self-Test Report:

The graphic host sends an "Application Test" Message:

Host to Display, MT to SR

DDC/CI Sequence: S-6Ea-51a-81a-B1a-0Fa-P

6E	Destination address
51	Source address
81	Length
B1	Command
0F	Checksum

The "Application Test Reply" Message is read by the Host:

Display to Host, Slave Transmit to Master Receive

DDC/CI Sequence: S-6Fa-6Ea-82a-A1a-00a-1Dn-P

6F	Destination address
6E	Source address
82	Length
A1	Data
00	Status
1D	Checksum

In this example, the display returns its current status [00], indicating no problem.

6.4 Definition and Use of the “Null Message”

A NULL message can be defined without any data bytes, i.e., the “length byte” is 0x80:

Display to Host, ST to MR

DDC/CI Sequence: S-6Fa-6Ea-80a-BEn-P

6F	Destination address
6E	Source address
80	Length
BE	Checksum

The NULL message is used in the following cases:

- To detect that the display is DDC/CI capable (by reading it at 0x6Fh I²C slave address)
- To tell the host that the display does not have any answer to give to the host (not ready or not expected)
- The “Enable Application Report” has not been sent before using Application Messages

6.5 Communication Between the Host and its Devices

Several basic rules apply to the DDC/CI host and its devices in order to have good communication performances.

6.5.1 Message Buffer Size Requirements

The I2C bus specification requires that a host be able to send and receive messages of any size up to the maximum of 131 bytes (127 + 4). But for DDC/CI, the maximum permitted length is 32 bytes of data to minimize the risk of bus contention and to keep the required buffer size in the display to a reasonable size/cost. Messages longer than 32 bytes must be transmitted as a number of 32 byte fragments, the last fragment may be less than 32 bytes if message is not a multiple of 32 bytes.

It is recommended to have independent transmit and receive buffers in order to simplify the implementation of error recovery and retry mechanisms in case of failed communication.

Obviously, a device must properly send and receive all its supported command and data structures. This determines the minimum internal data communication buffer size for proper display operation.

The device shall acknowledge all received data bytes from the host, even if the message is larger than the maximum size supported by the device.

If the host attempts to read more data bytes than specified by the “length byte”, extra bytes of any dummy value will be read, in order to avoid a “hang” situation. However, the Host is responsible to read the correct number of bytes.

With DDC/CI, it is possible to share the same memory in the device for both the receive and transmit buffers, due to the smart host communication error recovery mechanism.

6.6 I²C Bus Timings

The host must implement I²C bus error recovery systems (see section 5 and I²C Specification).

The host shall abort and perform an error recovery if the SCL line is stretched low by other devices for more than 2 msec.

Since devices are slave devices and not driving the SCL line, they do NOT need to implement a 2msec SCL Low Watchdog¹ system, but must make sure that in a worst-case timing situation, the device does not stretch the clock low over 2 msec (i.e. MCU maximum interrupt latency). The SCL clock stretching duration should be kept as short as possible.

Technical Clarification: When the host sends a message to the display, the host must wait at least 40 msec before trying to read an answer from the display in order to avoid I²C bus bandwidth overhead. Since the display commands are initiated by the end-user, the 40msec response latency (equivalent of several video frames or one keyboard scan debounce period) is not critical.

If other I²C devices are on the bus, the time-interleaved message method is easier to implement on the host side.

¹ “Watchdog” refers to a periodic check performed to detect if the SCL line has been driven low – may be implemented in firmware.

6.7 Messages Support

Some simplifications can be done based on DDC/CI functionality and are described here.

6.7.1 Power Management

If display power management can be controlled over DDC/CI, it shall be handled by using the MCCS VCP code.

If the MCCS solution must coexist with DPM (DPMS), some guidelines are shown in section 11 of this document.

However, if the host supports both MCCS and DPM, both methods must be used by the OS to notify the display of any change in the requested power management level.

6.7.2 ID String

The ID String must be unique per device, and Vendor/Model Names must be consistent with EDID information.

6.7.3 Capability String

This table describes each capability string field and their support by DDC/CI.

Field	Comment
prot()	Mandatory
type()	Mandatory
model()	Mandatory
vdif()	Optional use in DDC/CI. It's data must be consistent with EDID information
cmds()	Mandatory.
vcp()	Mandatory. If MCCS power management is supported, the corresponding VCP code shall be reported.
vcpname()	Used to define specific additional VCP code(s) not referenced in MCCS standard. All codes not described in the MCCS specification should be described using this field. (See notes)
<i>custom fields</i>	Additional vendor specific fields can be added in the capability string. The keyword shall be approved by VESA in order to avoid conflict with other vendors.

Table 7 : Capability String Fields

Important: Generic PC host SW shall discard any unsupported capability fields.

Note: vcpname() is a special field to define some control codes that are not fully defined in the MCCS specification. Typically, only a software application provided or recommended by the display manufacturer will fully understand the function of these codes – it is recommended that these codes only be used when an application is confident that the functionality is fully understood.

6.7.4 Vendor Specific Messages

- “Data Stream messages” are vendor specific (“Protocol Flag” bit 7 of “Length byte” cleared)
- All “control/status messages” (except 0xC0h - C8h vendor specific) are reserved for future versions of DDC/CI

6.7.5 Application Specific Messages

The display does not have to initiate any message by itself:

- “Timing Report” message is sent only after the host sends “Get Timing Report” message.
- “Key Report” message is sent only after the host sends “Get Key Report” message.

6.7.6 Hot Plugging Mechanism

DDC/CI supports hot plugging, provided the display can detect a disconnection of the video cable. When the display detects an “unplug” event, it resets its DDC/CI function and disables the Application Message Reports.

The host should regularly poll the device ID String to check for device presence (e.g. every 3 sec).

If the DDC/CI slave address is not acknowledged after “trial and error recovery” attempts, the host shall consider that the DDC/CI function is no longer available (detached).

If the DDC/CI slave address is acknowledged but a NULL message is returned in place of a application reply message, the host shall assume that a new DDC/CI device has been attached.

Anytime a DDC/CI device is attached, the host should get both the ID String and Capability String, then enable the Application Message Report.

Note: Some interface specifications, e.g. DVI, include hardware-based hot plugging detection mechanisms. In these cases, use of the DDC/CI based method is not recommended.

7. DDC/CI Support of Display Dependent Devices

The DDC/CI communication allows optional addition of display dependent devices. As an example, a touch-screen device is used in this section.

There are 2 different ways to implement the touch screen:

- As a slave device using DDC/CI protocol, but located at a different I²C slave address (e.g. 0xF0h / F1h)
- As integrated/embedded in display device HW architecture (unique I²C address for both: 0x6Eh / 6Fh)

7.1 External Display Dependent Device

In this example, the implementation is simple: a fixed I²C slave address is defined for the touch screen device (0xF0h / F1h). The application specific touch screen commands are defined in the Access Bus Locator Device Protocol spec.

7.1.1 Message Sent to the External Device

The “source byte” (0x51h) is replaced by the odd device address (i.e. 0xF1h)

7.1.2 Message Sent (Reply) from the External Device

The “source byte” (0x6Eh) is logically replaced by the even device address (i.e. 0xF0h)

7.2 Internal Display Dependent Device

When the touch screen is integrated in the display device, there is only one I²C Slave address (0x6Eh / 6Fh) shared by both the display and the touch screen. In this configuration, the message discrimination / routing is done as follows:

7.2.1 Message Sent to the Internal Device

The “source byte” (0x51h) is replaced by the external device odd address (i.e. 0xF1h).

7.2.2 Message Sent (Reply) from the Internal Device

The “source byte” (0x6Eh) address byte is 0xF0h.

Except for the destination I²C address, the communication of a display dependent device is the SAME for both internal and external devices.

7.3 Detection of Display Dependent Device

The device detection is done by attempting to access the external I²C address first (acknowledge).

Then the host must detect the presence of an internal device by sending an “Identification Request” to the internal device and check if the “Identification Reply” is successful. If not, a NULL message will be returned, meaning no internal devices are present.

7.4 Example of Internal and External Device Communication

We will consider both situations where the touch screen is external or internal:

Example: The graphic host wants to get the Touch Screen Self-Test Report:
The graphic host sends an "Application Test" Message:

External: Host to Touch Screen

DDC/CI Sequence: S-F0a-F1a-81a-B1a-31a-P

F0	Destination address
F1	Source address
81	Length
B1	Op code
31	Checksum

Internal: Host to Touch Screen

DDC/CI Sequence: S-6Ea-F1a-81a-B1a-AFa-P

6E	Destination address
F1	Source address
81	Length
B1	Op code
AF	Checksum

The "Application Test Reply" Message is read by the Host:

External: Touch Screen to Host

DDC/CI Sequence: S-F1a-F0a-82a-A1a-00a-83n-P

F1	Destination address
F0	Source address
82	Length
A1	Op code
00	Data
83	Checksum

Internal: Touch Screen to Host

DDC/CI Sequence: S-6Fa-F0a-82a-A1a-00a-83n-P

6F	Destination address
F0	Source address
82	Length
A1	Op code
00	Data
83	Checksum

In this example, the touch screen returns its current status [00], indicating no problem.

7.5 Dependencies Between the Display and Integrated Devices

Some commands sent to the display, such as those concerning power management, may affect integrated devices.

Technical Clarification: When the host communicates with an internal device, the host **MUST** read any expected answer from the internal device before attempting to communicate with the display. This allows for cost optimized implementations, where both the display device and the internal device are sharing the same communication buffer.

8. DDC/CI Implementation Examples

This chapter provides some examples of DDC/CI system implementations.

8.1 Multiple Video Interface Support and Implementation

A unique DDC I²C bus for each video interface shall be implemented.

8.2 Television/Home Theater Support and Specific Commands

Specific dedicated functions exist in the MCCA specification.

8.3 Video Switch Boxes

Video switch boxes allow a single display to be attached to more than one computer system. System designers should assume that the video channel is linked with the DDC bus, meaning that switching the video channel from one host to another will also apply to the DDC channel.

8.4 Multiple Display Support

Two forms of ‘expander boxes’ are common:

- Video amplifier
 - Used to replicate the same data on multiple screen e.g. conference room or school application
- Video splitter
 - Used to split the incoming signal into several areas to drive a large display consisting of several discrete displays e.g. a video wall

The expander box should primarily behave as a single display for the benefit of the host application software.

In both examples, it is good design practice to put a DDC/CI “hub” that will have one DDC channel going to the PC and a separate independent I²C bus (I²C master) going to each attached display. This hub should build the correct EDID and properly translate and dispatch the DDC/CI display control commands to each attached display device.

If the expander box supports both “amplifier” and “splitter” modes, the modes can be controlled by the host using a custom VCP code (using vcpname keyword in the capability string).

For instance, in splitter mode, DDC/CI can be used to address each display individually by considering them as “internal only” display dependant devices. In the example of the 3 x 3 wall display (comprised of 9 discrete displays), this could be done by using free addresses (“source byte”) 00/01, 02/03, 04/05 for the top row, 06/07, 08/09, 0A/0B for the middle, and 0C/0D, 0E/0F, 10/11 for the bottom.

For the duplicator mode, the previous enumeration could correspond to the video output channel number of the expander box.

Note: Since the expander box is relaying messages to its attached displays, the response time must be increased from 40msec to 120msec.

8.5 Video Projection Displays

Video projectors are display devices and can support DDC/CI.

If a secondary monitor display can be connected to the video projector, a number of implementations are possible and can vary in complexity. One solution would be to consider the video projector as a multiple video expander box.

9. DDC/CI Compliance

Compliance with the VESA DDC/CI Standard requires that the requirements of all sections are met.

Figure 1 shows the key elements of DDC/CI implementation, the host device (often a PC) acts as an I²C Single Master Host and the display acts as an I²C Slave Device.

The maximum transfer rate in “standard-mode” is 100 kb/s equivalent to a maximum clock rate of 100 kHz. Note that this standard assumes “standard-mode” operation in all examples but this does not preclude operation in either “fast-mode” (400 kb/s) or “high-speed mode” (3.4Mb/s) – see I²C specification for details .

9.1 Existing Display Designs

Existing display designs (any DDC layer) will not conflict with a DDC/CI capable host.

9.2 New Display Designs

DDC/CI does not interfere with any other DDC communication layer.

Older implementations of DDC based communications (e.g. DDC2B+ and DDC2AB) can be easily enhanced to support DDC/CI.

However, it is recommended to put a 12 to 15 kohm pull-up resistor on both SDA and SCL signal lines in order to achieve optimum communication speed in a noisy environment, or when a VGA expander cable is used.

Technical clarification: Placing a 12k Ohm resistor in parallel sharpens the rising edges at the display side without significantly affecting the equivalent resistor on the bus or the maximum sinking current, thus allowing for optimum communication.

9.3 Existing Graphic Host Systems

Existing host systems (any DDC level) are not in conflict with DDC/CI capable displays.

9.4 New Graphic Host Systems

New host designs shall not use less than 2.2k Ohm (5%) pull-up resistor on both SDA and SCL lines.

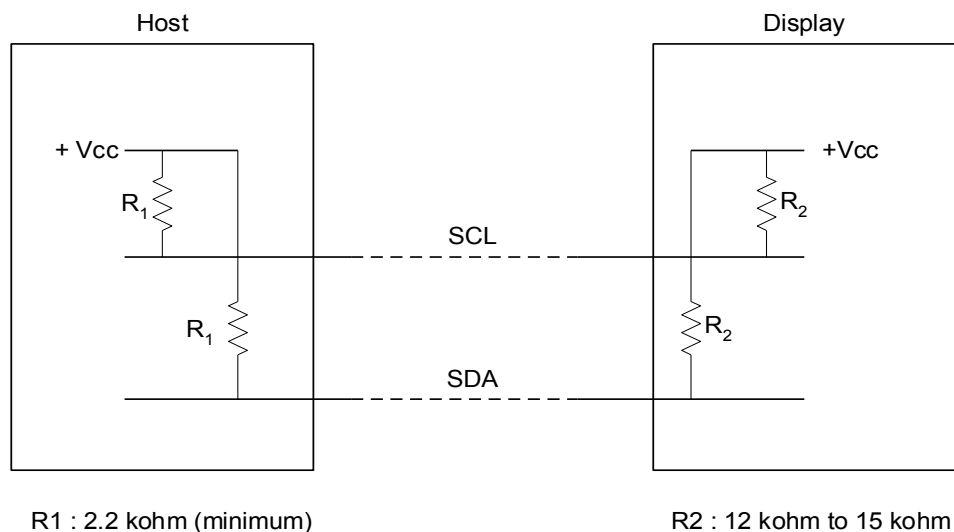

Figure 2 - Recommended SCL and SDA Line Terminations

10. Appendix A: Co-existence of DDC/CI and HDCP

Care must be taken if the DDC/CI link is being used for multiple purposes ... for example, if it is being used both to control a display and for key exchange in HDCP (High-bandwidth Digital Content Protection) scheme.

HDCP has a number of maximum response times for communication and, if these are exceeded, communication will be interrupted - see table 2-1 of HDCP System specification (version 1.1) for a summary.

Caution: All designers and users of DDC/CI should ensure that they are compliant with the appropriate standards and, in particular, that control of the bus is released whenever possible.

11. APPENDIX B: DPM (DPMS) and MCCS Power Management

Note: Appendixes are NOT part of the standard.

While DPM and MCCS power management can coexist on the display side, conflict can result if they are not handled properly by the host.

For best results, if the host supports both power management systems, they should be used together, as follows:

In a display supporting both DPM and MCCS, the recommended rules are:

- A. The GetVCP(power management) always returns the current physical monitor power state.
- B. By default, the DPM solution is used.
- C. The MCCS solution is used over DPM once:
 - The host has sent “Enable Application Report” message,
 - AND has set the power management level using the SetVCP() command message.
- D. When the video cable is DISCONNECTED:
 - (e.g. sensing VGA Pin 9), DPM is used.
 - If the “Disable Application Report” message is received by the display, DPM is used.

The implementation in the Graphic Host driver is possible (ACPI-On Now Power Management) using:

```
DWORD __cdecl GetMonitorPowerStateCaps(DEVNODE devnode)
```

Parameters:

None.

Returns:

Bitmask of:

CM_POWERSTATE_ON

CM_POWERSTATE_OFF

When the display uses the DPM mode by default, using “GetVCP(0xD6)” will then report the Display Current power management level, regardless of the power management request’s source. As such, if the monitor enters into a safety mode (X-Ray protect, for example), Power Off mode will automatically follow. If the host then sends GetVCP(0xD6), the display will naturally respond 00.

Zero power and host wake-up by a device: If the host is in stand-by mode, a device could wake-up the host (interrupt) by sending the Start/Stop bit sequence on the I²C bus.

12. Appendix C: Summary of Op. Codes

Op Code (Hex)	Function	Op Code (Hex)	Function
F1	Identification request	E1	Identification reply
F3	Capabilities request	E3	Capabilities reply
B1	Display self-test request	A1	Display self-test reply
07	Timing request	06	Timing reply
01	VCP request	02	VCP reply
03	VCP set	09	VCP reset
E2	Table read request	E4	Table read reply
E7	Table write	-	
F5	Enable application report	-	
0C	Save current settings	-	

13. APPENDIX D: Answers To Commonly Asked Questions

Note: Appendixes are NOT part of the standard.

	Question	Answer
1	Current displays cannot return from DDC2AB+ back to DDC2B mode. What about DDC/CI?	DDC/CI is identical to DDC2B+ in this regard. However, if the display is capable of decoding both A0h / A1h and 6Eh / 6Fh addresses, such a problem does not exist for DDC/CI
2	Does DDC/CI support hot plugging?	Yes, by regularly checking the device ID or I ² C Address acknowledge. This is the classic method.
3	Does DDC/CI requires additional slave address decoding in the display HW?	No, the 6Eh / 6Fh address is the same as DDC2B+, except that the 6Fh address had been previously undefined.
4	What are the main advantages of DDC/CI compared to DDC2B+ ?	DDC2B+ requires an intensive CPU SW polling method to emulate host slave addressing (with interrupts disabled) and can disturb other computer functions. DDC/CI uses the I ² C single master function (like DDC2B) and does not require additional CPU bandwidth. Furthermore, no interrupts are suspended during the communication.
5	What is the minimum I ² C bus speed?	From the Access Bus Spec 3.0, chapter 2.1.8 Timing Rules, Paragraph 2.1.8.2 “Bus Timing”: No device can stretch the clock low more than 2 msec. However, except for the host, all devices shall have an I ² C byte HW interface and minimize any clock stretching delays. NOTE: The “2msec time-out” SW implementation in a device is NOT required in DDC/CI mode (no multi-master mode)
6	Why not use the A0h / A1h I ² C address?	Because it would be in conflict with Extended EDID definition in the VESA DDC Standard. Also, some possible devices (e.g. 24LC21) may be connected on the same bus and decode all AX I ² C addresses.
7	What is the advantage of DDC/CI compared to DDC2B?	Color Matching and Abstract Implementation is possible, regardless of the video channel implementation and display type. Possible to perform specific color adjustments and save the display settings host hard disk drive for each user profile.
8	Is DDC/CI host SW graphic card dependant?	Some current implementations are graphic dependent since they address the graphic chip registers. Other implementations use a (largely) undocumented API in Windows XP and 2000 operatings systems to achieve hardware independence (assuming that graphic chip DLL supports the API).
9	Does the DDC/CI host SW depend on the monitor used?	No, the host SW is generic, and will work with any display that complies to the DDC/CI and MCCS specifications.
10	Does the monitor vendor need to supply the DLL to the OS?	The DLL may be supplied with the control panel software, i.e. with the graphic board driver software.
11	How can I test my graphics card DDC/CI drivers?	One solution is to contact DDC/CI display manufacturers, or test at VESA PlugTests. (if your company is a member)

Table 8 - FAQ

THIS PAGE INTENTIONALLY LEFT BLANK